

July 1995

# Electronics **NOW**

Combined with  
**Radio Electronics**

## How to make the **Internet Connection**

A look at the best ways  
to get online

View color negatives on a  
video monitor with  
an easy-to-build

**Video Inverter**

Use your PC as  
an inexpensive

**Cable Tester**

A look at the

**Early Days  
of Television**

and the people who shaped it

How to put smart

**Alphanumeric Displays**

to work in your next project



\$3.50 U.S.  
\$3.95 CAN.

 A GERNSBACK  
PUBLICATION



# CONTENTS

JULY 1995

**ON THE COVER**

**31 GETTING CONNECTED TO THE INTERNET**

From its early beginnings in the late 1960s as a government networking experiment, the Internet has grown into a global information resource. The Internet is basically a network of computer networks, ranging from universities, to government institutions, to private industries. The Internet has something to offer for everyone, including individual computer users as well as businesses of all sizes. There are already over 30 million active internet users, and approximately 160,000 new users are accessing the Net each month. What exactly is the Internet, how can you benefit from it, and how do you get on it? Those questions and more are answered on page 31.

— Stephen J. Bigelow

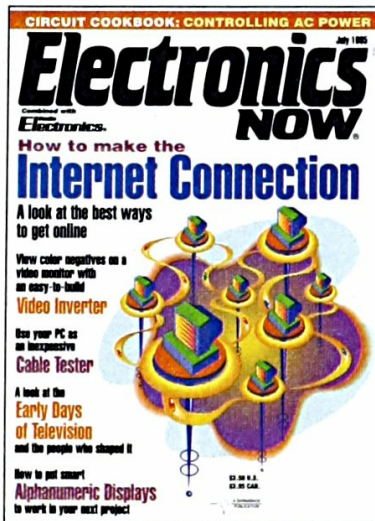

**BUILD THIS**

**41 VIDEO INVERTER**

Invert your camcorder video output to view photographic negatives.

— Joseph L. Sousa

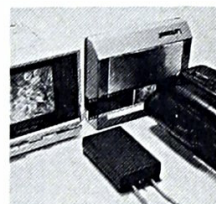

**51 WORKING WITH SMART DISPLAYS**

Learn how to program "smart" LED multicharacter displays.

— Jerry R. Lettow

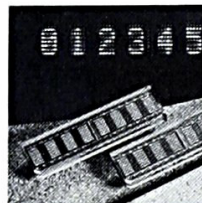

**69 CABLE TESTER**

Let the power of your PC perform multipath continuity testing.

— James J. Barbarello

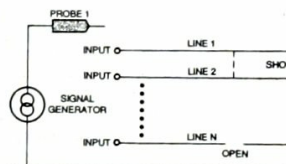

As a service to readers, ELECTRONICS NOW publishes available plans or information relating to newsworthy products, techniques and scientific and technological developments. Because of possible variances in the quality and condition of materials and workmanship used by readers, ELECTRONICS NOW disclaims any responsibility for the safe and proper functioning of reader-built projects based upon or from plans or information published in this magazine.

Since some of the equipment and circuitry in ELECTRONICS NOW may relate to or be covered by U.S. patents, ELECTRONICS NOW disclaims any liability for the infringement of such patents by the making, using, or selling of any such equipment or circuitry, and suggests that anyone interested in such projects consult a patent attorney.

ELECTRONICS NOW, (ISSN 1067-9294) July 1995. Published monthly by Gernsback Publications, Inc., 500-B Bi-County Boulevard, Farmingdale, NY 11735. Second-Class Postage paid at Farmingdale, NY and additional mailing offices. Canada Post IPM Agreement No. 334103, authorized at Mississauga, Canada. One-year subscription rate U.S.A. and possessions \$19.97, Canada \$27.79 (includes G.S.T. Canadian Goods and Services Tax, Registration No. R125166280), all other countries \$28.97. All subscription orders payable in U.S.A. funds only, via international postal money order or check drawn on a U.S.A. bank. Single copies \$3.50. © 1995 by Gernsback Publications, Inc. All rights reserved. Printed in U.S.A.

POSTMASTER: Please send address changes to ELECTRONICS NOW, Subscription Dept., Box 55115, Boulder, CO 80321-5115.

A stamped self-address envelope must accompany all submitted manuscripts and/or artwork or photographs if their return is desired should they be rejected. We disclaim any responsibility for the loss or damage of manuscripts and/or artwork or photographs while in our possession or otherwise.

# VIDEO INVERTER



***Invert your  
camcorder video output  
to view photographic negatives.***

JOSEPH L. SOUSA

THE VIDEO REVOLUTION IS IN FULL swing, capturing the world in sound and action. The still camera has been capturing treasured moments for more than a century. Both cross paths in this video inverter project which lets you view positive, color-corrected photographic images on a video monitor.

Have you ever held a color negative up to a light and tried to view it? It's difficult to identify the picture, let alone judge its photographic merit. But if you use the macro setting on your camcorder to focus on a back-lit photographic negative, the video inverter presented here will let you see a positive, color-corrected image on a TV screen or video monitor. Illumination is provided by a small commercially available light box or you can improvise one with a fluorescent bulb. A set of inexpensive plastic filters between the light source and the negative let you maintain color balance for

various film types, lighting conditions, and personal taste.

The video inverter lets you run your own mini photo lab. You can look at your negatives on-screen and crop them to obtain the best composition. A TV screen will show you how an actual enlargement might look. You can experiment with exposure and color balance to fine-tune the mood of the picture. You can also record your favorite still shots on videotape for easy group viewing.

The video inverter can also save you money. Say, for example, that you return from vacation with five rolls of film to be developed. At \$5 to \$15 per roll for standard prints, your bill could add up to as much as \$75. But if you have a video inverter and a camcorder, just tell the photo lab that all you need is developed negatives, which should cost only about \$15 for all five rolls. Then you can view the negatives on a TV screen

and choose only the shots you want to be printed by the photo lab—or make a video tape of them and forget about the prints! If you have your own darkroom, you can use the video inverter to preview color or black and white negatives before printing.

## **How it works**

As you probably already know, a photographic negative is dark where the resulting print will be light and, conversely, the negative is light where the print will be dark. This is very straightforward for black-and-white negatives, but a little bit more complicated for color negatives. The principle of opposite color values is used to impress color on negative film. If you place red, magenta, blue, cyan, green, and yellow at equidistant points on a circle as shown in Fig. 1, the color on a negative will be exactly opposite that of the color print on the color wheel. For ex-

ample, a red rose appears cyan (blue-green) on the negative, a yellow rain jacket appears blue, and green grass appears magenta (purple).

Another characteristic of a

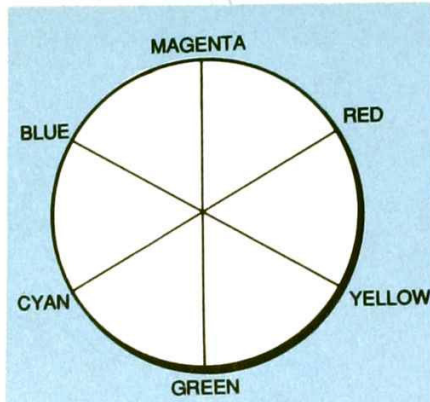

FIG. 1—THIS COLOR CIRCLE, or color wheel, shows the different colors that are the opposites.

color negative is that the photographic emulsion is suspended on a brown plastic film. The brown hue varies from orangy-brick to purplish or gray-green, depending on the manufacturer of the film. To recreate the original positive image from a negative, as is done routinely in the photographic print making process, one must invert light and dark, exchange each color value for the opposite value, and neutralize the brown hue of the negative.

### The video signal

The NTSC RS-170 video signal carries luminance and chrominance information along with synchronization signals. The luminance part of the video signal carries information about the light and dark areas

of the picture. The chrominance part—3.58 MHz color subcarriers—carries hue information and color saturation information. The hue is determined by the subcarrier's amplitude, and the saturation is determined by its phase. The vertical- and horizontal-sync pulses mark the beginning of each picture frame and each line, respectively.

The colorburst contains eight cycles of a 3.58-MHz sine wave that acts as a reference to allow demodulation of the chrominance signal. The phase difference between the chrominance signal and the colorburst determines the hue.

The circuit inverts the luminance and chrominance signals in the NTSC output from a camcorder, as shown in Fig. 2. How-

Reversed

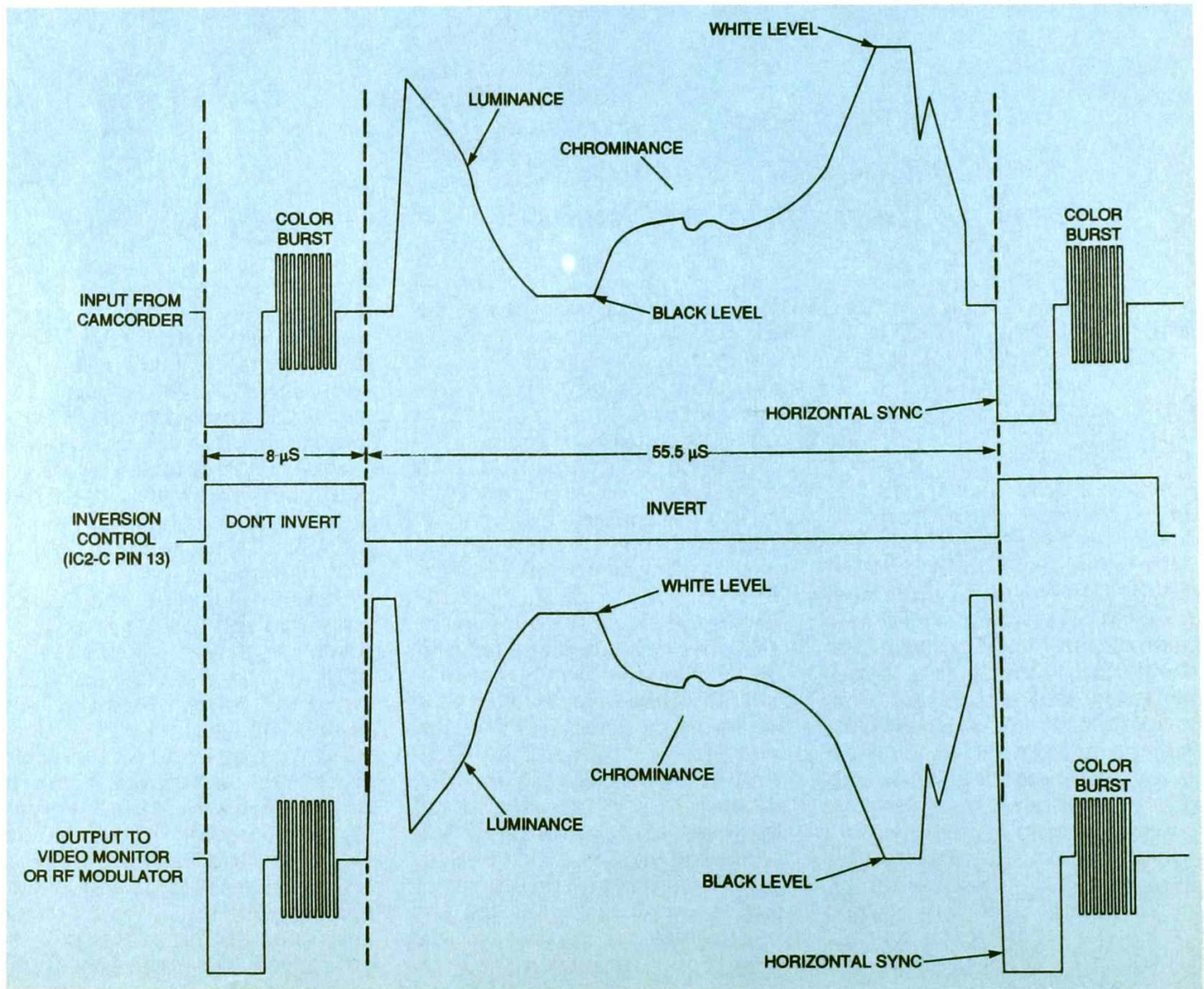

FIG. 2—BY INVERTING THE NTSC VIDEO SIGNAL, photographic negatives can be viewed as positives on a TV screen.

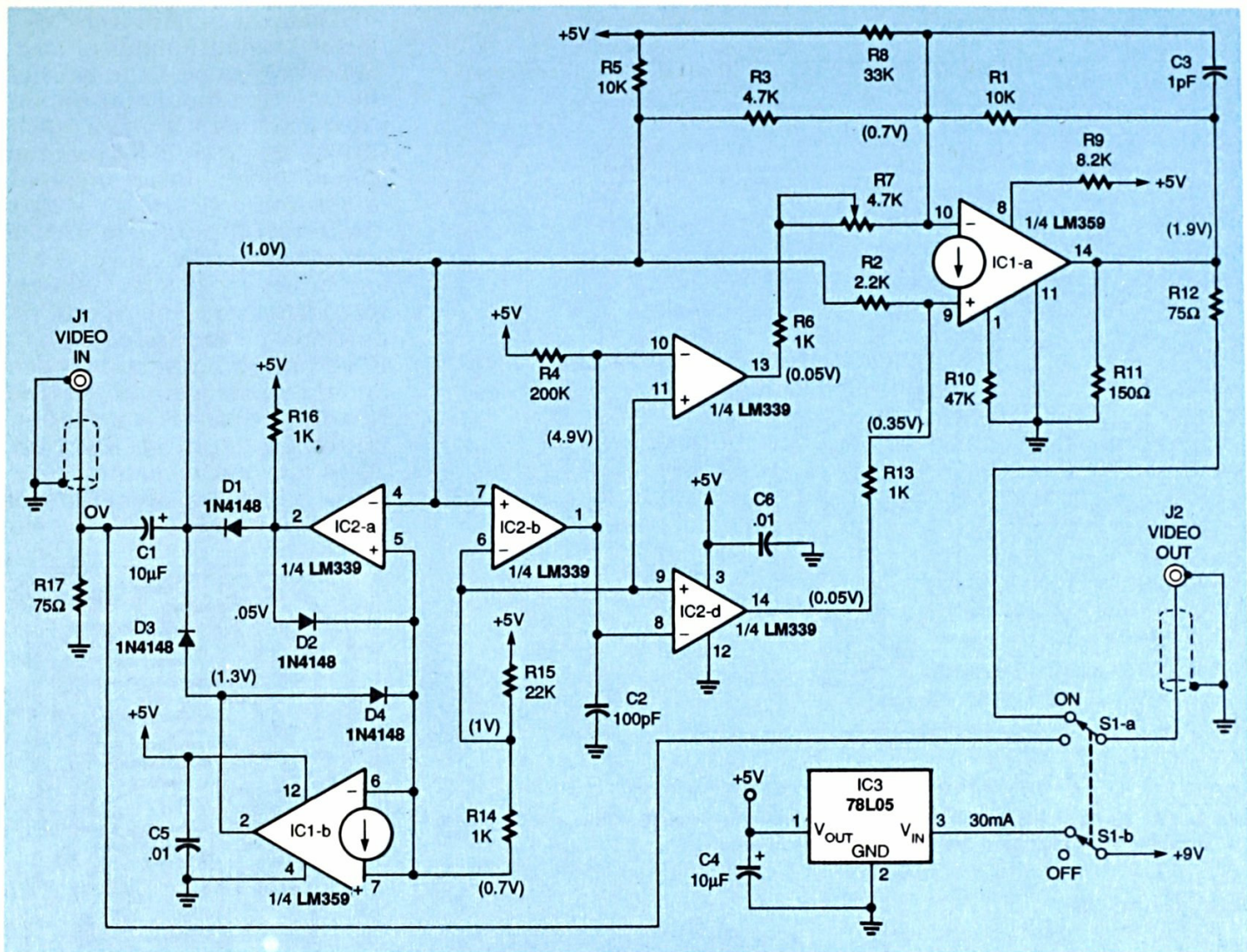

FIG. 3—SCHEMATIC DIAGRAM OF VIDEO INVERTER. The circuit is based on an LM359 dual Norton op-amp and an LM339 quad voltage comparator.

### PARTS LIST

All resistors are 1/2-watt, 5%

- R1, R5—10,000 ohms
- R2—2200 ohms
- R3—4700 ohms
- R4—220,000 ohms
- R6, R13, R14, R16—1000 ohms
- R7—4700 ohms, trimmer potentiometer
- R8—33,000 ohms
- R9—8200 ohms
- R10—47,000 ohms
- R11—150 ohms
- R12, R17—75 ohms
- R15—22,000 ohms

#### Capacitors

- C1, C4—10  $\mu$ F, electrolytic
- C2—100 pF, ceramic
- C3—1 pF, ceramic
- C5, C6—0.01  $\mu$ F, ceramic

#### Semiconductors

- IC1—LM359N Norton op-amp (National Semiconductor or equiv.)
- IC2—LM339N quad comparator (National Semiconductor or equiv.)
- IC3—78L05 5-volt regulator
- D1—D4—1N4148 switching diode

#### Other components

- S1—DPDT miniature toggle switch
- J1, J2—male/female RCA jacks and

shielded cable (see text)

**Miscellaneous:** Case (Radio Shack 270-293), 9-volt battery clip, 9-volt battery or battery eliminator (Radio Shack 273-1552), mini light box (Letraset Mini-Pro), Roscolux plastic filters (Edmund Scientific N39,417), PC board, wire, solder

#### ORDERING INFORMATION

- A single-sided PC board is available for \$15.00 from Joseph L. Sousa, 38 Cornish St., Lawrence, MA 01841-1226. Check or money order, only.
- A Letraset Mini-Pro light box is available from Charette, 31 Olympia Ave., Woburn, MA 01888, 617-935-6000
- A similar, compact light box is available for \$19.95 + S&H from Visual Horizons, 181 Metro Park, Rochester, NY 14623-2666, 716-424-5300, Fax 716-424-5313
- The Roscolux filters are available from Edmund Scientific Company, 101 E. Gloucester Pike, Barrington, NJ 08007-1380, 609-573-6250

ever, it leaves the vertical sync, horizontal sync and colorburst uninverted.

A blue *roscolux* plastic filter between the negative and the light source is usually required to neutralize the brown tint in the negative and adjust for proper color balance. However, some video cameras have a manual white-balance control that can achieve good color balance without the filters.

Properly decoding an NTSC video signal without losing potential image resolution is challenging because the luminance frequency spectrum overlaps and interleaves with the chrominance spectrum. All of the video inverter's processing is done without splitting the luminance and chrominance into separate signals to avoid any loss of resolution. The blue plastic filters eliminate the need to demodulate and potentially degrade the NTSC video signal.

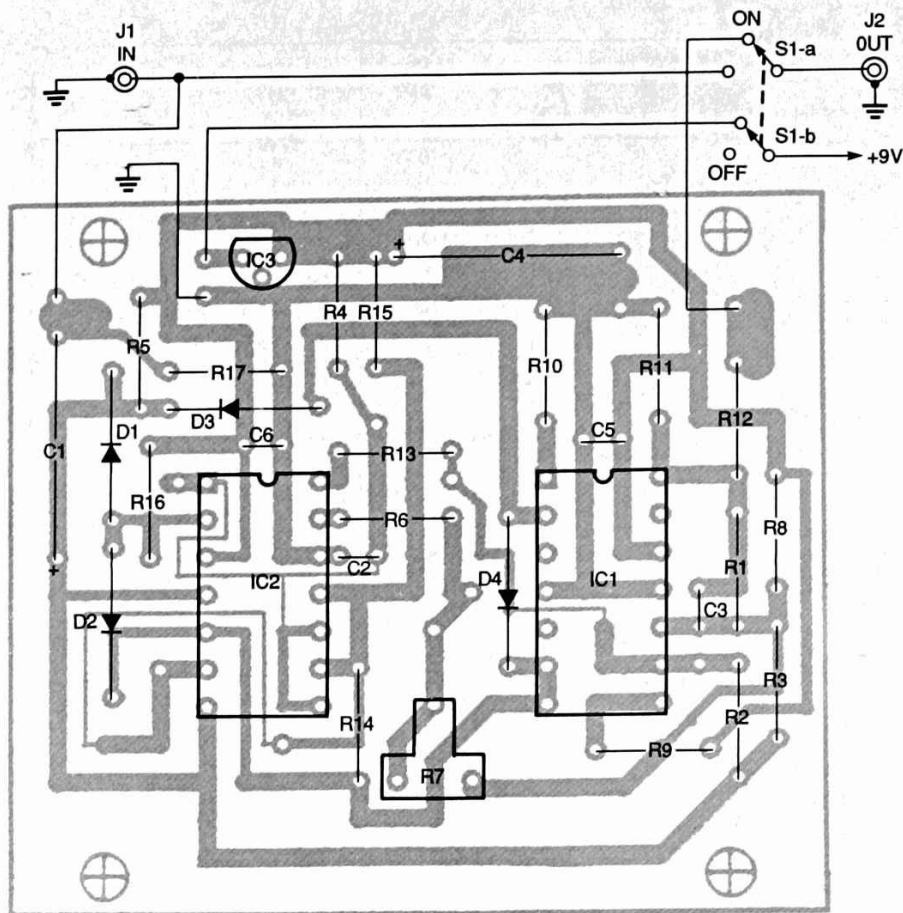

FIG. 4—PARTS-PLACEMENT DIAGRAM. First install the three ICs, followed by polarized capacitors, diodes, and then the rest of the components.

### Circuit details

The video inverter circuit, shown in Fig. 3, is based on an LM359 dual Norton op-amp and an LM339 quad voltage comparator. Those two ICs handle DC restoration, sync detection and processing, and buffering and inversion of the video signal. The DC level of the video signal is restored to 0.7 volt because the inputs of IC1-b operate at one diode voltage drop above ground. Diodes D1 and D3 charge the positive side of C1 to keep the bottom of the sync pulses at +0.7 volt, and D2 limits the maximum output of IC2-a at pin 2 to +1 volt.

Comparator IC2-b acts as a threshold detector set to detect sync pulses 300 millivolts above the restored DC level of 0.7 volt. Components C2 and R4 stretch the detected 4-microsecond sync pulses to 8 microseconds to include the duration of 8 cycles of 3.58 MHz color burst after the input sync pulse. Comparators IC2-c and -d buffer the stretched sync pulse with open-collector outputs at pins 13 and

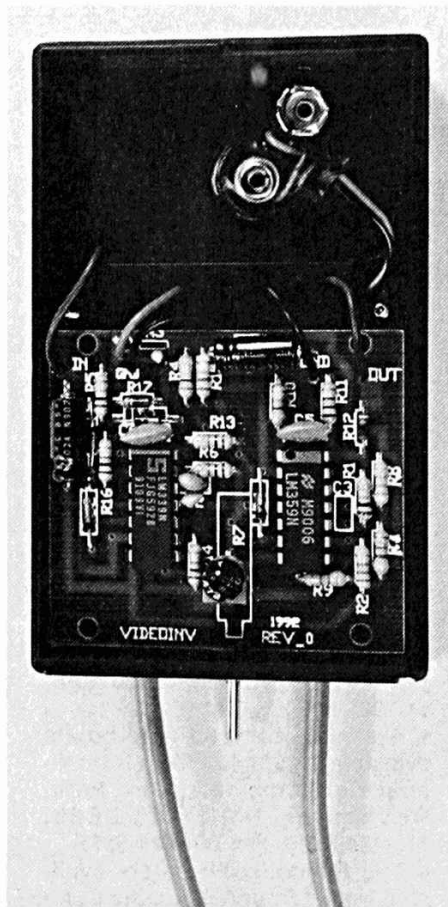
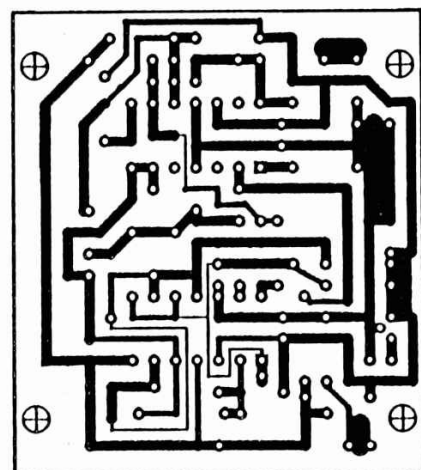

FIG. 5—THE PC BOARD is designed to fit in the specified case without the need for screws.

14 to gate the buffer/inverter action of the main amplifier IC1-a.

Resistor R3 sets the gain of the inverting input of the main video amplifier IC1-a to 2 ( $-R1/R3 = -2\times$ ), while R4 sets the gain of the non-inverting input of IC1-a to 4 ( $R1/R4 = +4\times$ ). These two inputs combine to achieve an overall gain of  $+2\times$  as a buffer or  $-2\times$  as an inverter. During sync and colorburst portions of the input signal, IC2-c and -d outputs are open and the overall gain is  $+2$ . The rest of the time a low at the output of IC2-d (pin 14) short circuits the non inverting  $+4\times$  signal path for an overall gain of  $-2\times$ , while a low at IC2-c pin



VIDEO INVERTER FOIL PATTERN.

13 injects the necessary offset in the inverted video signal to keep it above the black level. Potentiometer R7 adjusts the black level at the output to correspond to the peak white level in the negative. Resistor R12 matches the output for 75 ohms.

A 78L05 regulator (IC3) provides a stable 5-volt supply from a 9-volt battery or AC adapter. With a current drain is about 30 milliamperes, a 9-volt alkaline battery should last about 10 hours. The 78L05 will output a steady 5 volts until the battery drops to 7 volts. At that point the image colors will start washing out before the circuit stops working completely. Switch S1 turns power on and off, and also bypasses the input video signal around the video inverter circuit when it's turned off.

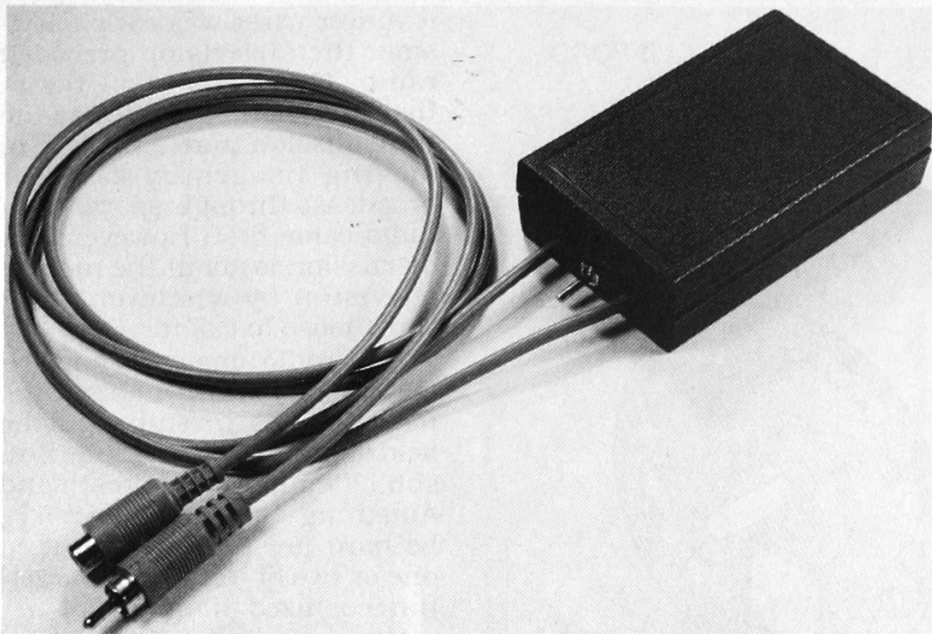

**FIG. 6—COMPLETED VIDEO INVERTER.** This compact unit connects directly to other video equipment.

### Construction

For best performance, build the video inverter on a PC board. A foil pattern is provided here if you want to make your own board, or you can purchase one from the source given in the Parts List. The PC board was designed to fit in a particular case (see Parts List) without the need for screws. The case contains a compartment for a 9-volt battery. You can use the mounting holes on the board if you choose a different case.

Figure 4 is the parts-placement diagram for the PC board. First install the three ICs, followed by polarized capacitors, diodes, and then the rest of the components. Before connecting the cables, inspect the board for solder bridges, especially between the pins of ICs. Installing the 9-volt battery clip lets you use either a 9-volt battery or a 9-volt battery eliminator.

Drill a  $\frac{3}{16}$ -inch hole on the front panel for the power switch. Locate the hole  $\frac{1}{4}$ -inch from the bottom of the panel so that the switch won't interfere with the PC board. Place a small piece of cardboard between the bottom of the PC board and the cable connections to S1 to avoid short circuits.

Input jack J1 is a male RCA plug connected to the end of a shielded cable. This will connect directly to the video output

of a camcorder. The output jack J2 can be either a female RCA jack to connect to a camcorder's RF modulator, or another male RCA jack to connect directly to a video monitor or VCR; either should be connected to the board by a length of shielded cable. A convenient way to simplify wiring the jacks is to buy a ready-made 3-foot patch cord with your choice of jack and plug on each end and cut it in half. Then solder the cut ends to the inverter circuit. You must also drill holes in the case's front panel to pass the input and output cables through. Figure 5 shows the board seated in the case, and Fig. 6 shows the assembly all buttoned up.

### Test and adjustment

Before you close-up the case, you must adjust R7 for the proper black level of the inverted video signal. The best way to make this adjustment is to apply power to the video inverter with the input and output cables unconnected, and then adjust R7 for a reading of 1.9 volts at J2. If you don't have a voltmeter, set R7 about midway. Then, once the inverter is connected to a camcorder, finely adjust R7 to make the black parts of the picture look right. The schematic diagram in Fig. 3 shows several DC voltage readings taken with the input and output cables un-

connected. You can use them to help troubleshoot the circuit.

To view negatives, set a small light box vertically in front of the video camera, and hold the negative to the box with a piece of clear acetate. Cover the area over the light box that is not used to view the negative with aluminum foil to reduce glare and reflect as much light as possible through the negative. The Roscolux filters measure  $1\frac{1}{2} \times 3\frac{3}{4}$  inches and are just big enough for a 35 mm negative.

The camcorder must be set to its macro setting and placed right in front of the negative. The camcorder should be free to move back and forth to obtain the best composition.

Wear cotton gloves intended for photographic use to handle the negatives to avoid leaving fingerprints.

If your camcorder has a manual white balance control try using it to remove the blue cast that the inverted color negative will produce on the video screen. If the white balance control doesn't do a good enough job, use the Roscolux filters. The right filter choice requires some experimentation. If the image is too blue, add a blue filter. If the image is too red, lighten the blue filter. If the greens are weak and the image is too purple, add a purple filter. It seems paradoxical, but if there is too much of one color on the video screen, you must add more of that color to the negative. Use the less saturated, lighter filters, such as the No. 848, No. 849, No. 850, No. 842, No. 804, and No. 825 filters. In various combinations, those Roscolux filters are most useful for viewing negatives from different types of color film.

Set the color, tint, brightness, and contrast controls on the TV or video monitor for normal viewing before using the video inverter. You can tweak them to achieve the best image afterwards. If your TV set decodes the vertical interval reference (VIR) signal that is normally broadcast by networks and TV stations, be sure to turn the VIR switch off while you are using the video inverter.  $\Omega$